



LITHIUM

PSX30

3,000 lbs. Capacity

Walkie Straddle Stacker



Why choose between price and quality **WHEN YOU CAN HAVE BOTH!**



HIGHLIGHTS

- ▶ American Curtis Travel Controller with CAN-bus control
- ▶ Full free lift mast
- ▶ Brushless DC permanent magnetic drive motor
- ▶ Lithium battery: 24V/100Ah
- ▶ Built-in charger
- ▶ Fast charging 4 hours
- ▶ Smart handle with keyless pin-code panel, RFID card and LCD display with battery indicator, hour meter and fault code
- ▶ Pinwheel turning - drive with tiller in vertical position
- ▶ Ergonomic control handle with horn and emergency belly button, dual butterfly-style thumb controls for traveling
- ▶ Electric lifting and lowering buttons
- ▶ Travel speed: 2.8mph (unloaded), 2.6mph (loaded)
- ▶ Speed reduction in turns
- ▶ Adjustable base legs
- ▶ Gradeability: 10% (unloaded), 4% (loaded)
- ▶ USB connector

PSX30

3,000 lbs. Capacity

Walkie Straddle Stacker

The PSX30 Lithium Walkie Straddle Stackers are economical, quiet, very low maintenance, ultra-smooth, and are perfect for light and medium duty material handling. Their compact design, small turning radius and full free lifting mast make them ideal for supermarkets, internal workshops, loading docks, narrow aisles, and applications within confined spaces like retail stores, trailers, containers, and warehouses.

FULL FREE LIFT MAST

The full free lift mast allows the forks to be raised to a significant height without extending the inner mast channels, allowing operation within spaces with limited overhead clearance.

Free Lift Height 51.2" - 70.9" | Lifting Height 100" - 167"

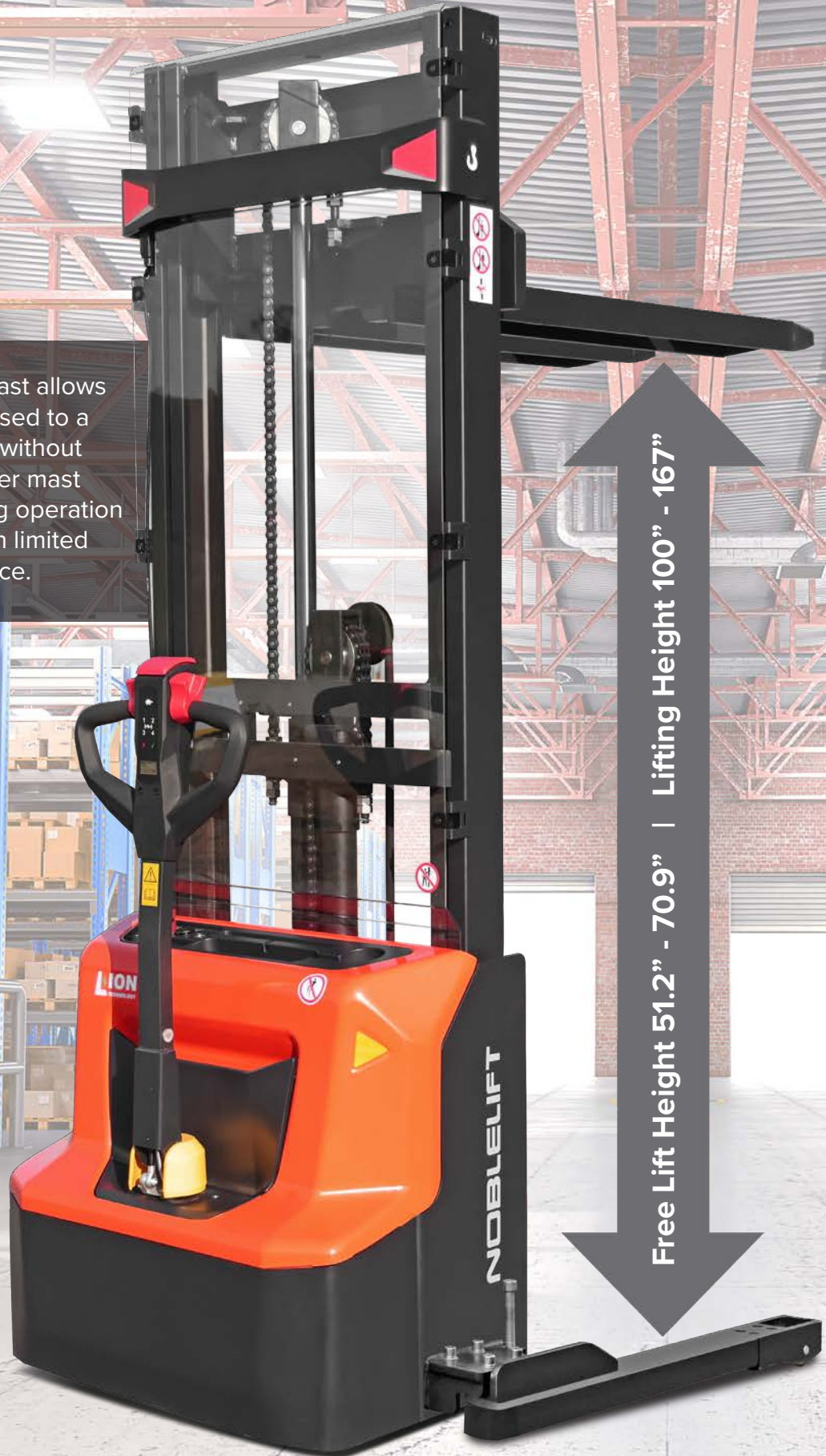

ERGONOMIC AND SMART TILLER DESIGN

Automatic speed reduction, while turning, helps to prevent product damage.



The new generation tiller head has soft grips for comfortable and ergonomic operation. The buttons are larger and can be easily used by operators, even while wearing gloves.

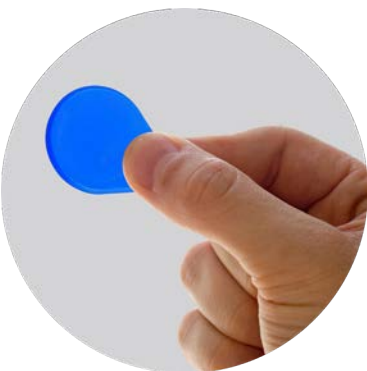

RFID Card Access provides faster access to equipment and is ideal for applications when one truck needs to be used by different operators.



PINWHEEL CAPABILITY FOR CONFINED SPACES



Turning
Radius

53"

Right Angle Stack with
40x48 Pallet

79.8"

By holding the Turtle button down, the stacker will operate with the handle in the upright position (pinwheel capability), providing safe and easy operation within confined spaces. Dual Butterfly-style thumb controls allow for effortless traveling.

HIGH EFFICIENCY AND GREAT VISIBILITY



Built-in charger, emergency stop button, and USB connector for charging and powering of additional devices during operations.

The PSX30 Walkie Straddle Stacker can easily fit into a cargo lift.

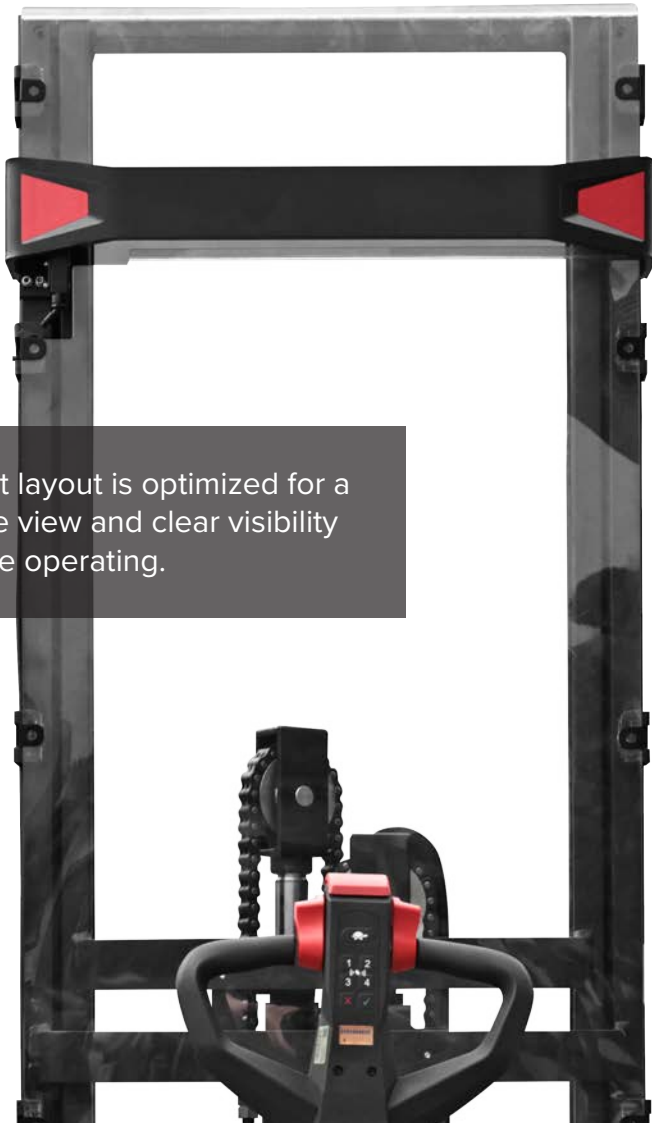

Mast layout is optimized for a wide view and clear visibility while operating.



Straddle support legs are easily adjusted to meet operator's needs: I.D. 38.62" to 50.43", O.D. 46.5" to 58.3". Stacker is equipped with a load back rest as standard equipment.

3-Point Structure Design.

Centered drive wheel provides excellent traction and stability. Casters are located to the left and right for additional stability. Straddle legs are equipped with single rollers.

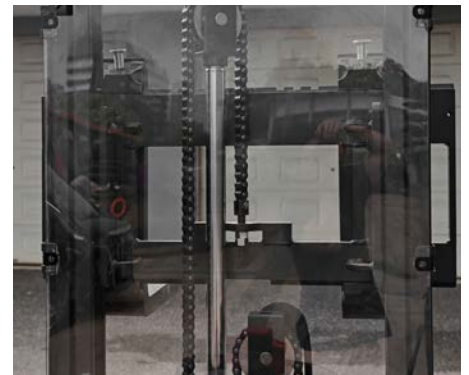

Clear, high-impact Plexiglass mast guard protects operator from chains and cylinder.



Capacity up to 3,000 lbs and ability to overcome ramps up to 4/10% (laden/ unladen) makes the PSX30 suitable for work in loading docks and on delivery operations.

**Up to 4/10%
(laden/ unladen)**

RUGGED AND SMART DESIGN



High-strength, patented chain turning structure ensures long stacker life and reliable lifting.



Engineered with soft start technology for enhanced stability and controlled lifting.



Frame is surrounded by steel, providing protection to the stacker's components and the operator's feet during work.



Tiller bar is supported by an air spring that returns the tiller to its vertical position without impact.



Innovative steel CJ channel mast design delivers added strength, stability and performance.



Load backrest prevents loads from falling backward, protecting the operator, the load and the stacker.

EASY MAINTENANCE



External programming port for diagnosing faults without removing the cover.



Patented wheel pressure bolt allows for adjustment without lifting up the stacker.



Easily check stacker's condition and troubleshoot with Curtis controller and CAN-bus technology.

APPLICATIONS

- Supermarkets
- Internal workshops
- Loading docks
- Narrow aisles
- Applications within confined spaces
 - Retail stores
 - Trailers
 - Containers
 - Warehouses



LONG LASTING AND SAFE LITHIUM POWER







NOBLELIFT uses LiFePO4 chemistry, the longest lasting and safest lithium battery chemistry available. Our lithium batteries are equipped with a Battery Management System (BMS), thermal management system, and an automotive-grade DC high-voltage control system. BMS manages charging and discharging data to ensure safety throughout its life cycle.

PSX30 Walkie Straddle Stackers have a 3 year or 6,000 hour warranty on the lithium battery cells.



ADVANTAGES OF LITHIUM POWER

LITHIUM BATTERY ADVANTAGES

Lead-Acid Battery		Lithium Battery
Lower fleet availability - Work is interrupted because battery needs to be fully charged before next use	Productivity - Memory Effect 	100% Fleet availability - Opportunity charging allows battery to be charged in between use
Periodic battery replacement	Service Life 	Batteries last 3 times longer and do not need to be replaced
Outsourced or in-house maintenance personnel required	Ongoing Maintenance 	No maintenance cost
8-10 Hours - 2 or more batteries per lift truck	Charge Duration 	4 Hours - 1 Battery per lift truck
Build an expensive battery room with ventilation	Battery Room 	No battery room needed
Releases hydrogen while charging - Can result in explosion - Acid burns can happen during maintenance	Dangerous Substances 	No dangerous substances
Power loss	Power Savings 	No power loss - Reduces energy consumption by 35%

Fast-charging maintenance-free Lithium battery is fully charged in 4 hours. Battery can be opportunity charged during user breaks and during shift changes which allows the truck to run continuously through multi-shift operations. No battery changes are necessary.



24V 100Ah Lithium LiFePO4 battery with BMS. Lithium battery has connection terminals with screws and is located inside the steel case.

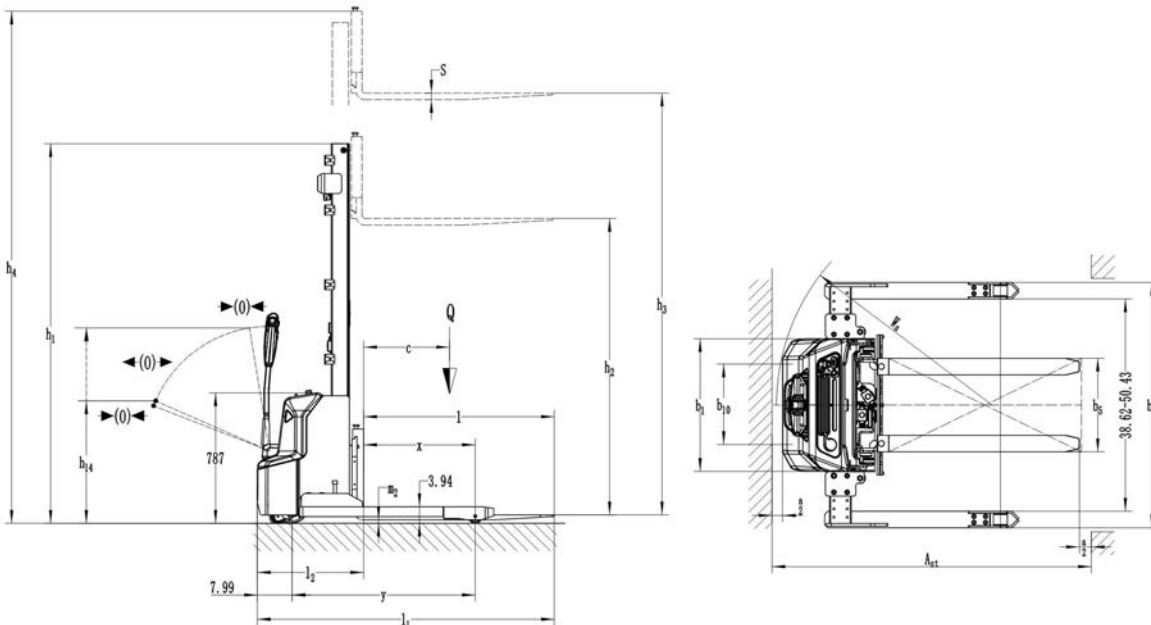

PSX30 Walkie Straddle Stacker					
Designation	Lowered mast height h1 (in)	Free lift height h2 (in)	Lift height h3 (in)	Extended mast height h4 (in)	Lift + fork height h3+h13 (in)
Two-stage mast	70.5	51.2	100	120.3	100
	76.4	57.1	110	132.2	112
	82.3	63	122	144.1	124
	90.2	70.9	138	159.8	140
Three-stage mast	78.4	56.6	167	188.5	167

Identification			
1.2	Model		PSX30
1.3	Drive (electric – battery or mains, diesel, petrol, fuel gas, manual)		Lithium
1.4	Type of operation (hand, pedestrian, standing, seated, order picker)		Pedestrian
1.5	Load capacity / rated load	Q (lb)	3,000
1.6	Load center distance	c (in)	24
1.8	Load distance, center of drive axle to fork	x (in)	26.5
1.9	Wheel base	y (in)	43.7
Weights			
2.1	Service weight with battery	lb	1,810
2.3	Axle loading, laden front / rear	lb	1,400 / 3,241
2.4	Axle loading, unladen front / rear	lb	1,312 / 529
Wheels, Chassis			
3.1	Tires (solid rubber, superelastic, pneumatic, polyurethane)		Polyurethane (PU)
3.2	Tire size, front	Øxw (in)	Ø 8.27 x 3
3.3	Tire size, rear	Øxw (in)	Ø 3.3 x 3.7
3.4	Additional wheels (dimensions)	Øxw (in)	Ø 3.9 x 1.6
3.5	Wheels, number front / rear (x = driven wheels)		1x+2/2
3.6	Track, front	b ₁₀ (in)	20.5
Basic Dimensions			
4.2	Lowered mast height	h ₁ (in)	90.2
4.3	Free lift height	h ₂ (in)	70.9
4.4	Lift height	h ₃ (in)	138
4.5	Extended mast height	h ₄ (in)	159.8
4.9	Height of tiller in drive position min./max.	h ₁₄ (in)	28 / 45.3
4.15	Height, lowered	h ₁₃ (in)	2
4.19	Overall length	l ₁ (in)	70.5
4.20	Length to face of forks	l ₂ (in)	25.2
4.21	Overall width	b ₁ (in)	31.5 / (46.5 / 48.5 / 50.4 / 54.4 / 58.3)
4.22	Fork dimensions	s/e/l (in)	1.57 / 3.94 / 42
4.25	Width across forks	b ₅ (in)	9.9 - 31.5
4.32	Ground clearance, center of wheelbase	m ₂ (in)	1.6
4.33	Right Angle Stack with 32x48 pallet	Ast (in)	79.8
4.55	Turning radius	Wa (in)	53
Performance Data			
5.1	Travel speed, laden / unladen	mph	2.6 / 2.8
5.2	Lift speed, laden / unladen	ft/m	19.7 / 27.6
5.3	Lowering speed, laden / unladen	ft/m	25.6 / 21.7
5.8	Max. gradeability, laden / unladen	%	4 / 10
5.10	Service brake		Electromagnetic
E-Motor			
6.1	Drive motor rating S2 60 min	HP	0.87
6.2	Lift motor rating at S3 7.5%	HP	3
6.3	Battery acc. to DIN 43531 / 35 / 36 A, B, C, no		/
6.4	Battery voltage, nominal capacity K2	V/Ah	24V/100Ah
6.5	Battery weight	lb	57.3
6.6	Energy consumption acc. to VDI cycle	HP*h	0.7
Others			
8.1	Type of drive control		DC
8.4	Sound level at driver's ear acc. to EN 12053	dB (A)	<70

NOBLELIFT reserves the right to make technical changes and improvements to our products to maintain or enhance the quality, delivery, and efficiency.

A GLOBAL LEADER

NOBLELIFT is a global leader in Lithium Technology. We manufacture more than 200 categories and around 30 series of each product. Our products are designed to meet different application demands and are well accepted by our customers in more than 100 countries and regions in Europe, America, Asia, Africa and more.

Products include: sit-down forklifts, rough terrain forklifts, narrow aisle forklifts, walkie-stackers, order pickers, electric pallet trucks, scissor lifts, tuggers, tow tractors, scrubbers/sweepers, lift tables, manual pallet jacks and more.



FORKLIFTS



NARROW AISLE



STACKERS



POWERED PALLET TRUCKS



SCISSOR LIFTS



TUGGERS



SCRUBBERS

NOBLELIFT NORTH AMERICA

2475 S. Wolf Road
Des Plaines, IL 60018
T: 847-595-7100
F: 847-595-7200
sales@nobeliftna.com
www.nobeliftna.com



Website



Video

AUTHORIZED DEALER

